

Data sheet | Item number: 756-3202/120-050

Connecting cable; angled; 12-pole; 5 m; fitted on one end (with free end);
M23 socket, straight

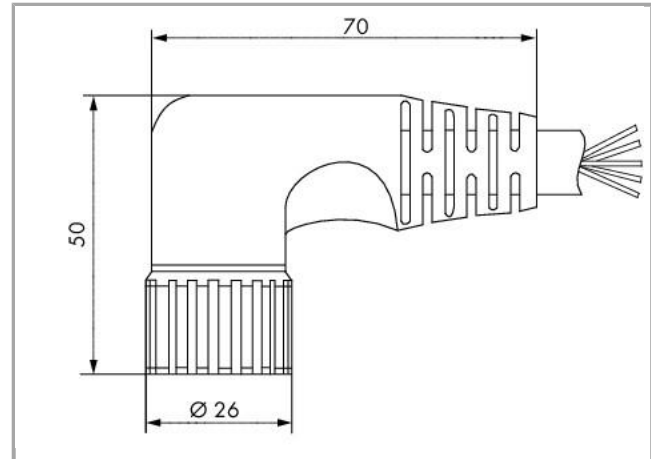

756-3202/120-050



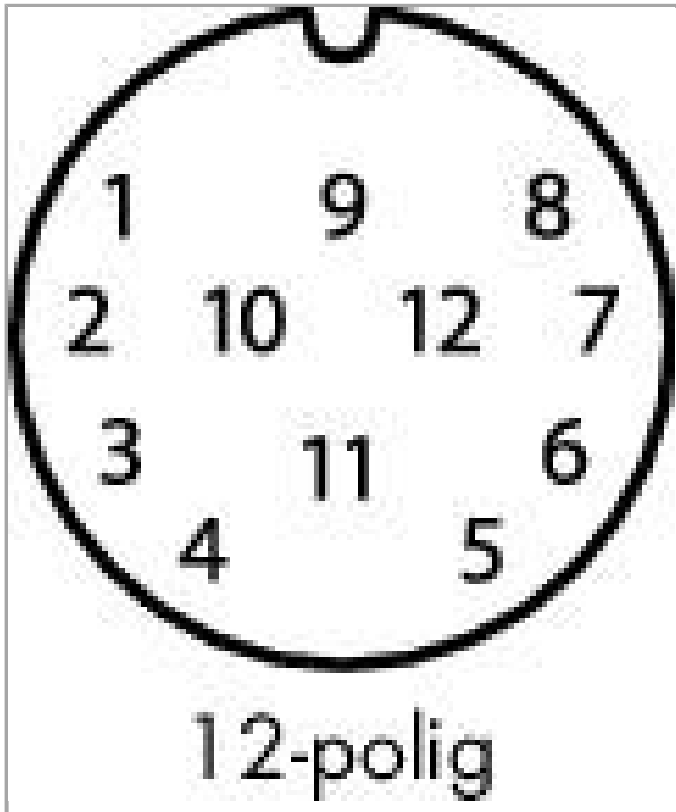

Pin 9, 11, 12: 1.00 mm²;
Pin 1 - 8: 0.34 mm²

1 white	9 blue
2 green	10 commoned with 9
3 yellow	11 brown
4 gray	12 green/yellow
5 pink	
6 red	
7 black	
8 violet	

Data

Technical Data

Connection type	M23 socket - free end
No. of poles	12
Leitungsanschlussrichtung zur Steckrichtung	90°
Cable length	5 m
Operating voltage	≤300 V
Operating current	8 A
Rated surge voltage	≥2,0 kV eff.

Mechanical data

Bending cycles	2 Mio.
Schleppkettentauglichkeit	yes
Durchmesser der Mantelleitung	9 ... 9.6 mm
Weight	587 g

Environmental Requirements

Umgebungstemperatur (Betrieb) bewegt	-25 ... +80 °C
Umgebungstemperatur (Betrieb) ruhend	-40 ... +80 °C
Protection class	IP67



Commercial data

Product Group	23 (I/O passive and accessories)
Country of origin	DE
GTIN	4044918569002
Customs Tariff No.	85444290900

Downloads

Documentation

System Description

Sensor/Actuator Boxes – General Product Information	pdf	Download
	537.3 kB	

Subject to changes.